

AUTOGLIDE

smart entry system

Instructions for fitting your Cardale Autoglide operator

IMPORTANT SAFETY INSTRUCTIONS FOR INSTALLATION

WARNING – INCORRECT INSTALLATION CAN LEAD TO SEVERE INJURY FOLLOW ALL INSTALLATION INSTRUCTIONS

 Before installing the operator check that the door is in good mechanical condition, and correctly balanced, and that it opens and closes properly.

 Do not use the force adjustments to compensate for a binding or sticking garage door. Excessive force will interfere with the proper operation of the Safety Reverse System or damage the garage door.



Do not wear rings, watches or loose clothing while installing or servicing a garage door operator.

 To avoid serious personal injury from entanglement, **remove any ropes** connected to the garage door before installing the door operator.

Install the remote mounted bell push button within sight of the door but away from any moving parts and at a height of at least 1.5 metres.

Permanently fix the label warning of entrapment in a prominent place or near the remote bell push button.

 **The safety reverse system** test is very important. The garage door must reverse when obstructed on closing. **Failure to properly adjust the operator may result in serious personal injury from a closing garage door.** Repeat the test once a month and make any needed adjustments (see **Section 7** in manual – Safety sensitivity check.)

 **SAFETY NOTE:** If there is a chance that children may play in the entry of the garage then ensure the child lock is **ENABLED** so that the door **CANNOT** be operated from the  button (see **Section 6c**).

CARDALE
GARAGE DOORS
Strong - Stylish - Secure

AUTOGLIDE

smart entry system



Installation and wiring must be in compliance with your local building and electrical codes. Connect the power cord only to properly earthed mains. Use a ring main 13 amp 3 pin socket installed by a qualified electrician. The plug should be fitted with a 5 amp fuse.

THIS APPLIANCE MUST BE EARTHED.

NOTE: For optimum electrical safety this operator should be connected to a circuit protected by an R.C.D. (max. 30mA trip rating)



If the garage has no service entrance door then an exterior release kit **MUST** be fitted. This accessory allows manual operation of the garage door from outside in case of power failure. (See back page)



Disconnect electric power to the garage door operator before making repairs or removing covers.



Use the manual release lever to disengage the motor drive **ONLY** when the drive is switched **OFF** and, if possible, when the door is fully closed.



Examine the installation, in particular the cables, spring and mountings, for signs of wear, damage or imbalance. Do not use if repair or adjustment is needed since a fault in the installation or an incorrectly balanced door may cause injury.

IMPORTANT SAFETY NOTE

Only operate the door when the door is in full view, free of obstacles with no persons (particularly children) near the door. Nobody should be allowed to enter or leave the garage whilst the door is in motion.

1 Pre-installation checks

A Fit **only** to Cardale CD 45 and CD PRO garage doors, conversion kits are required for fitting to other trackless gear systems. (See back page)

B Do not fit Autoglide to any door larger than 8' 0" wide × 7' 0" high (2438 × 2134mm).

C The timber "goalpost" frame must be a minimum of 70mm wide at the right-hand side of the door looking from the inside of the garage and the frame must be in good condition and securely fixed.

D Ensure the door is correctly tensioned and properly lubricated. The operator will not function properly if the door is poorly installed in any way. Also check that lifting cables and gear are in good condition.

E Prior to installing your Autoglide unit ensure all tools, etc are available inside the garage.

F Ensure that there is a suitably positioned 240v 13A socket outlet available inside the garage, this **must** be earthed.

AUTOGLIDE

smart entry system

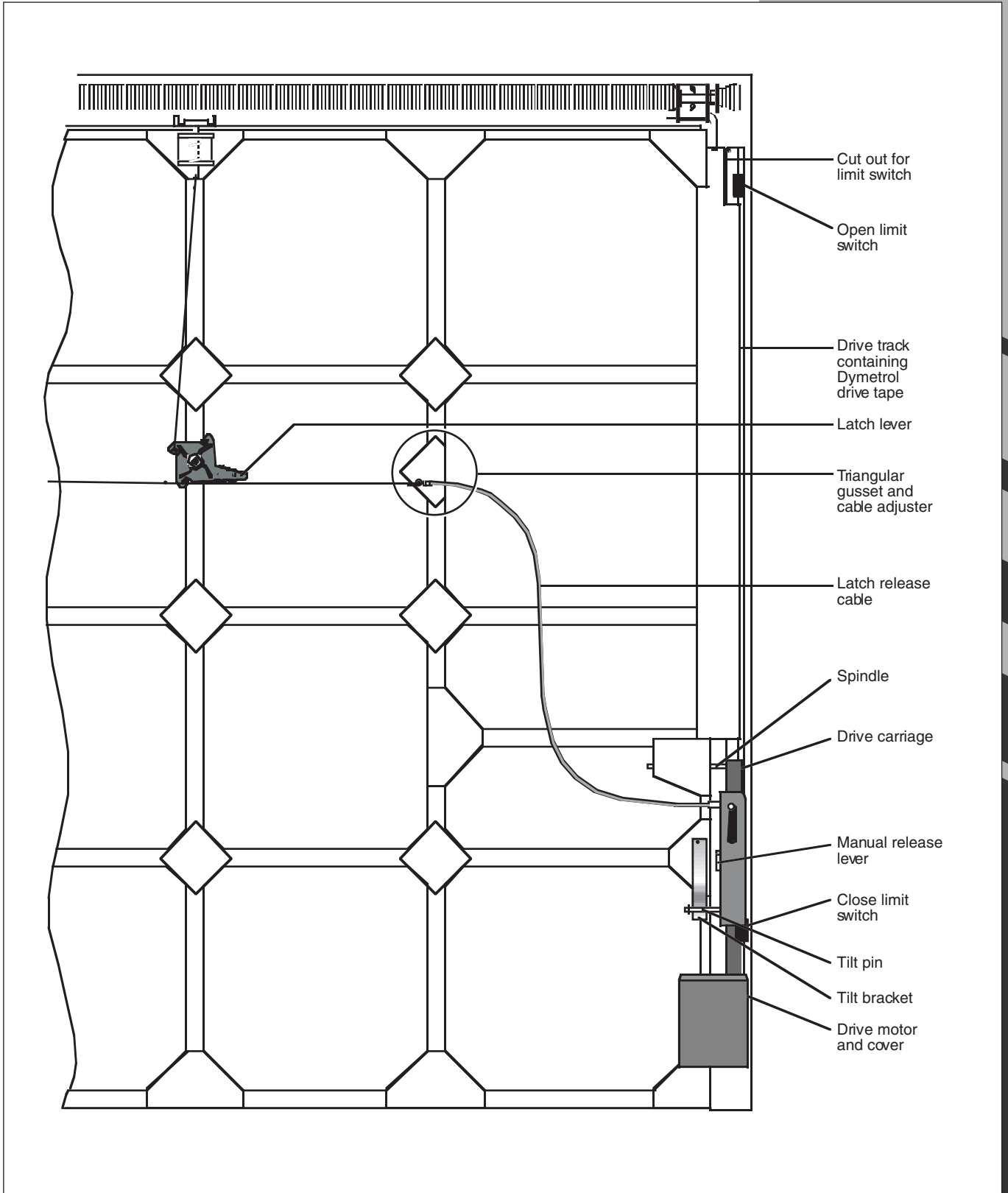

● View of Autoglide track unit from inside the garage (door bracing may vary)

AUTOGLIDE

smart entry system

2 Parts check list

Please check box contents and collect necessary tools



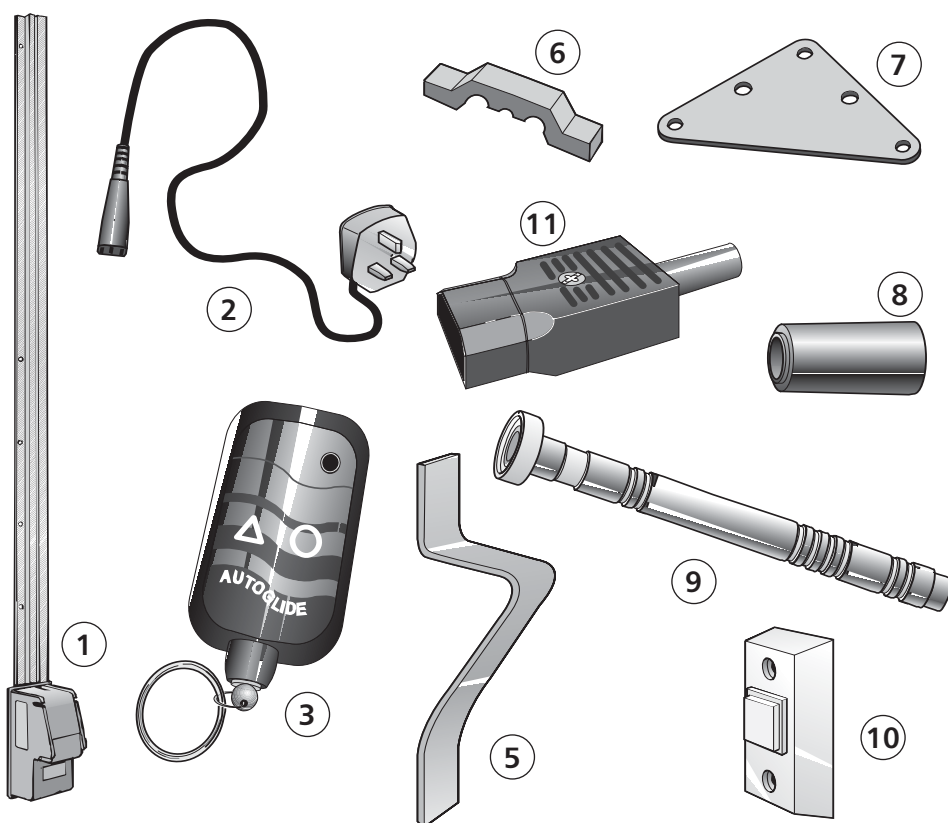







| ITEM NO. | PART CHECK | QUANTITY |
|----------|---------------------------------------|----------|
| 1 | Operator/track unit | 1 |
| 2 | Power lead | 1 |
| 3 | Handset | 1 |
| 4 | Assorted screws/fixing | 1 Bag |
| 5 | Tilt bracket | 1 |
| 6 | Cable clamp moulding | 1 |
| 7 | Gusset plate | 1 |
| 8 | Spacer | 1 |
| 9 | Special spindle | 1 |
| 10 | Push button control and fixings | 1 |
| 11 | Lamp output connector | 1 |
| 12 | Frame door fixing pack. | 1 |
| 13 | Lamp holder (where supplied) | |
| 14 | Latch release cable outer | 1 |
| 15 | Fittings/instructions pack for CD PRO | 1 |

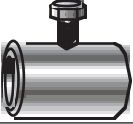

AUTOGLIDE

smart entry system

Contents of item 4 (bag)

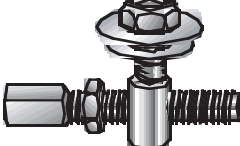
| QTY | ITEM | DESCRIPTION |
|-----|---|--|
| 3 |  | Track fixing screw No 8 × 1" S/tap C'/sunk |
| 2 |  | Chassis fixing screw No. 10 × 2" S/tap Pan HD |
| 2 |  | Cable tie |
| 2 |  | Gusset plate fixing No. 10 × 1/2" S/tap Pan HD |
| 2 |  | Yellow wall plug for push button and No. 4 × 1" S/tap C'/sunk screws |
| 1 |  | Cable clamp for latch cable |
| 1 |  | Split pin to retain door tension |
| 1 |  | Tilt bracket top fixing screw No. 10 × 3/4" S/tap Pan HD |
| 1 |  | Tilt bracket bottom fixing screw No. 8 × 3/4" S/tap C'/sunk |
| 2 |  | Cable clamp fixing No. 6 × 1/2" S/tap Pan HD |
| 1 |  | Star lock washer for spindle |
| 1 |  | Cable fixture plus nut and washers |

Tools required

- | | | | |
|---|------------------------------|----|------------------------------|
| 1 | Power drill | 6 | Pozidrive screwdriver |
| 2 | Masonry bits | 7 | 22mm A/F spanner |
| 3 | Steel drill bit 3.5 diameter | 8 | Hacksaw |
| 4 | Pliers | 9 | Small electrical screwdriver |
| 5 | Plain screwdriver | 10 | Tape measure |

NOTE: Where the garage door is the only means of access it is recommended that the optional Exterior Release kit is fitted.

AUTOGLIDE

smart entry system

IMPORTANT NOTE: If you are fitting to a door supplied with CD PRO gear use instructions supplied in item 15.

3 Fitting the track assembly

WARNING: The spring is under extreme tension – follow instructions carefully to avoid personal injury. If in any doubt at all consult a qualified installer (see Yellow Pages for details).

NOTE: If door is not yet fitted, fit door to opening only after completing stages **1** and **2** (refer to door fitting instructions). Do NOT fit latches at this stage.

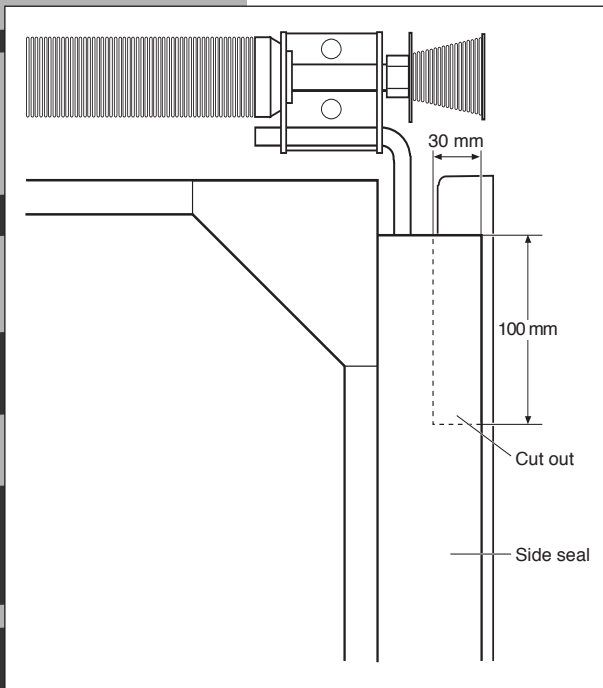

● Figure 1

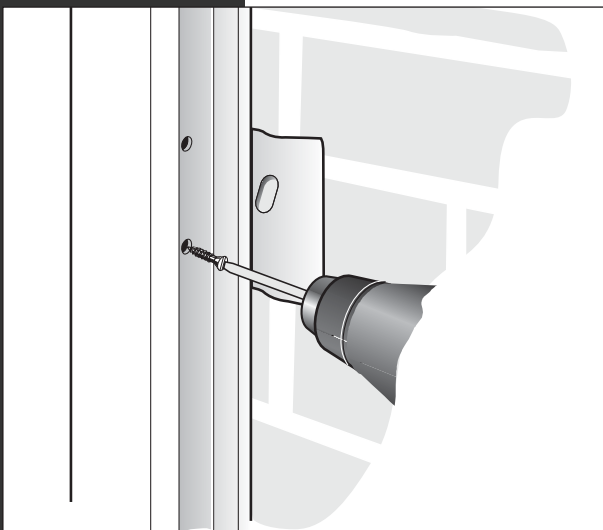

● Figure 2

- 1** Cut out a 30mm × 100mm rectangle in top of right-hand side seal of door (looking from inside garage) as shown in **Figure 1**.
NOTE: Later doors already have this cut out.
- 2** Replace existing spindle on right-hand side of door (looking from inside garage) with special spindle supplied in accessory pack as follows:-
 - a. Open door fully and remove screws from centre of right-hand runner (**Figure 2**).
 - b. Close door fully, ensuring latch is engaged. Grip right-hand (black) cone pulley with spanner and by turning upwards align holes in anchor bush and spring shaft. Insert retaining pin supplied fully into hole (**Figure 3**) – and remove spanner.
 - c. Remove right-hand side runner and security block by removing screws at top and bottom of runner (**Figures 4 & 5**).

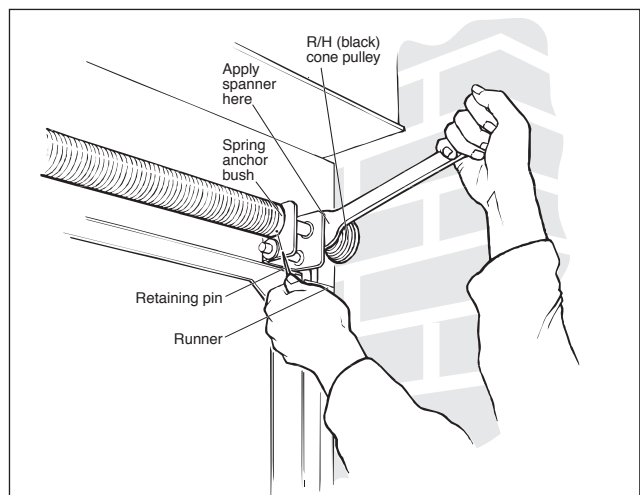

● Figure 3

AUTOGLIDE

smart entry system

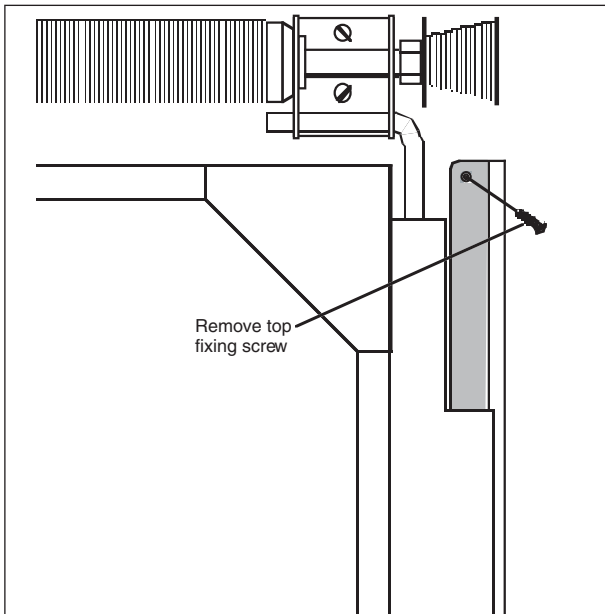

● Figure 4

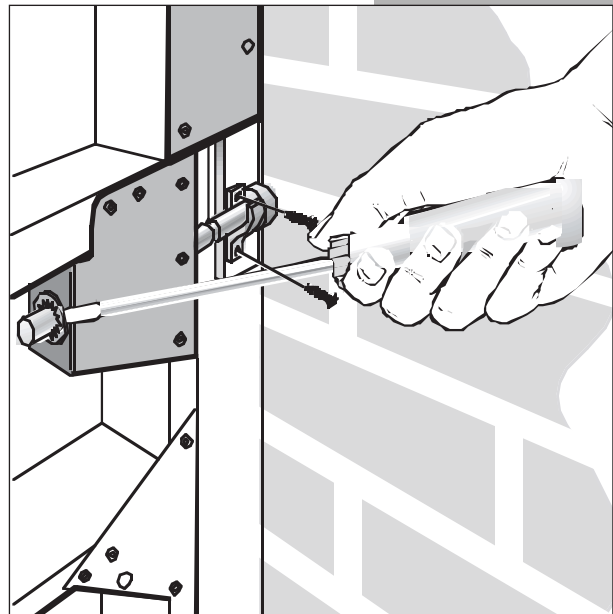

● Figure 5

d. Lever off star washer from inboard end of spindle with screwdriver (**Figure 5**).

NOTE: On later doors remove circlip.

e. Pull door slightly away from frame and remove spindle. Unhook from cable.

N.B. On some installations difficulty may be experienced in removing spindle pin because of restricted side room. In extreme circumstances door may have to be taken out.

f. Loop cable over new spindle, ensuring loop is located in groove (**Figure 6**).

g. Refit spindle through hole in bracket.

h. Push new star washer, correct way round, onto spindle using pliers (or suitable size pipe if available) ensuring there is no free play on spindle (**Figure 6**).

DO NOT REPLACE RUNNER

i. Remove retaining pin by reversing step b.

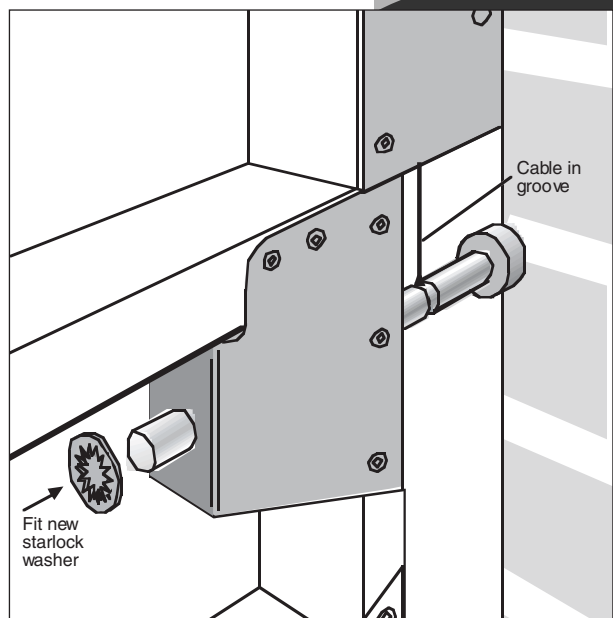

● Figure 6

IMPORTANT NOTE: On CD PRO doors fitted with “floating” wheel spindles you **MUST** fit nylon spacer to LH spindle to eliminate end float (see instructions in item 15).

AUTOGLIDE

smart entry system

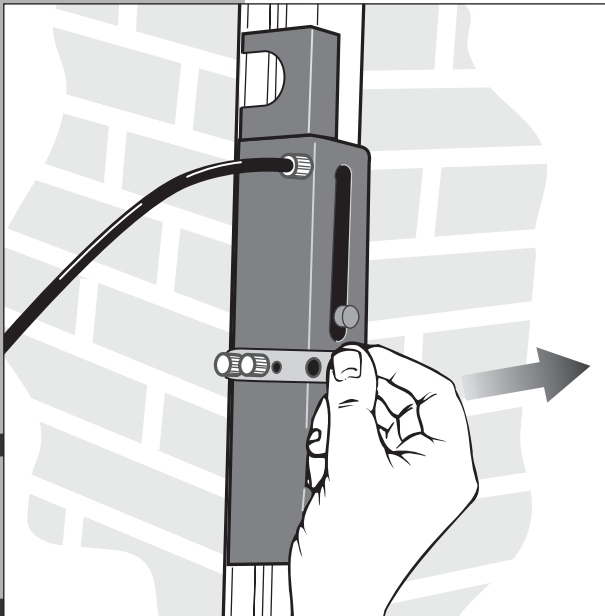

● Figure 7

- 3** If door has not yet been fitted, fit now (refer to door fitting instructions) but do not fit latches at this stage. If door is already fitted, remove all latches now.

ENSURE DOOR IS CORRECTLY TENSIONED AND LUBRICATED

- 4** Open door three quarters of full opening height.

- 5** Take the Autoglide track unit and operate manual release lever (Figure 7) by pushing towards drive carriage. This will disengage drive carriage from Dymetrol tape inside the track. Slide the carriage to a position approximately 305mm (12") from top of track.

- 6a** If door is fitted to a timber frame.

Offer track up to right-hand side of door and slide spindle into shaped recess in top of drive carriage (Figure 8a). Position top of track 25mm (CD45) or 6mm (CD PRO) from underside of top lintel (Figure 9). Ensure spindle fits comfortably in recess with 1.0mm clearance between end of spindle and carrier housing (Figure 8b).

Screw track to side jamb using 3 off No. 8 × 1" countersunk self tapping screws provided (Figure 11) ensuring track is parallel to side of door.

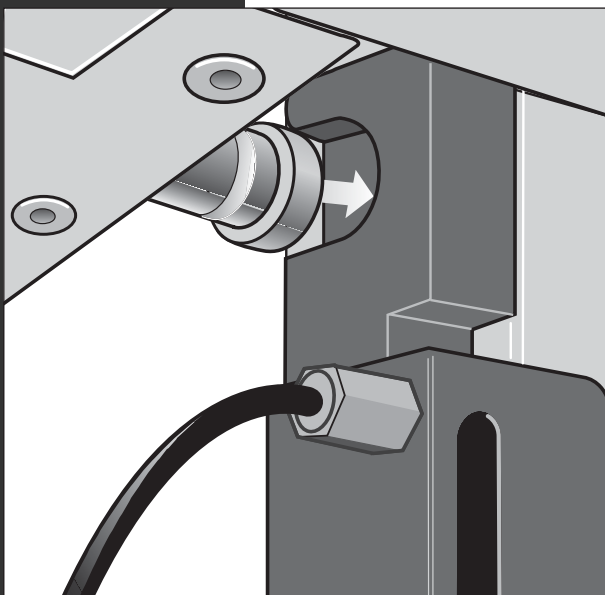

● Figure 8a

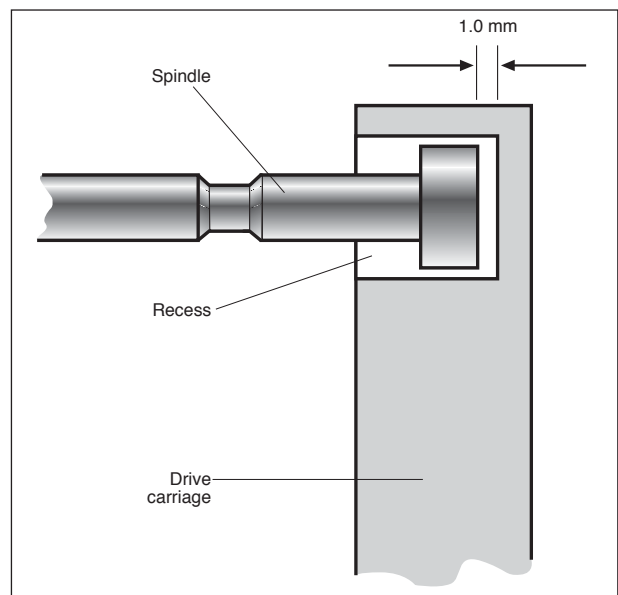

● Figure 8b

AUTOGLIDE

smart entry system

Secure the motor chassis with the two No.10 × 2" self tapping screws provided (Figure 11).

N.B. On bottom fixing use 1" black spacer insert provided, to place between chassis plate and frame. Ensure spacer is correct way round (see Figure 11). with the screw passing through the spacer.

OPEN/CLOSE DOOR SEVERAL TIMES TO ENSURE DOOR OPERATES FREELY.

6b If door is fitted to a Steel frame.

IMPORTANT: Your CD45/CD PRO framed door must be fitted correctly in accordance with the framed door fitting instructions for **behind the brickwork installation**. Unfortunately Autoglide cannot be fitted to a CD45/CD PRO framed door fitted between the brickwork (Figure 10).

- i Close door fully and prop securely in position. Remove ONE wall fixing bracket from right-hand frame side channel. Replace removed bracket with special cut down bracket supplied (parts list item 12).
- ii Repeat for other right-hand wall fixing bracket.
- iii Offer track to right-hand side of door and slide spindle into shaped recess in top of drive carriage. Align holes in track with pre-pierced holes in frame channel.
- iv Slide one $\frac{3}{16}$ " washer between channel and track and align with centre fixing hole. Fix track to channel using one No. 8 × 1" self tapping screw provided.
- v Repeat for other two holes in track.
- vi Secure the motor chassis by sliding one $\frac{3}{16}$ " washer under each fixing hole and using the two No 10 × 2" self tapping screws supplied. (Figure 11).

N.B. On bottom fixing use 1" black spacer insert provided, to place between chassis plate and frame. Ensure spacer is the correct way round (see Figure 11) with the screw passing through spacer.

OPEN/CLOSE DOOR SEVERAL TIMES TO ENSURE DOOR OPERATES FREELY.

***NOTE:** $\frac{3}{16}$ " WASHERS NOT REQUIRED ON CD PRO STEEL FRAMES

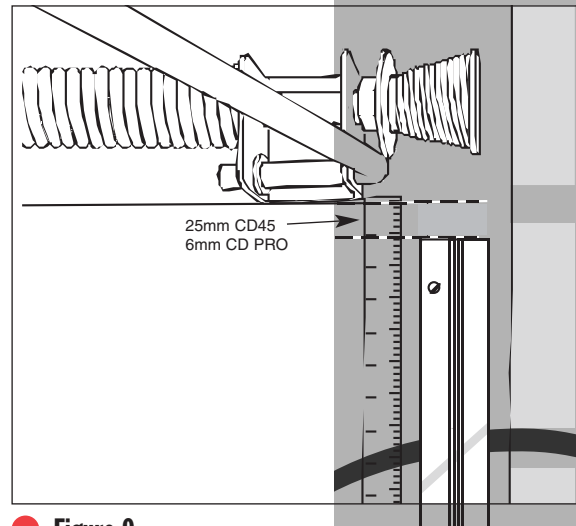

● Figure 9

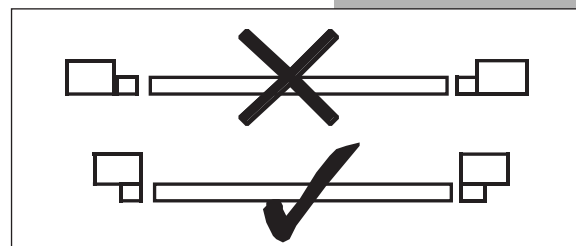

● Figure 10

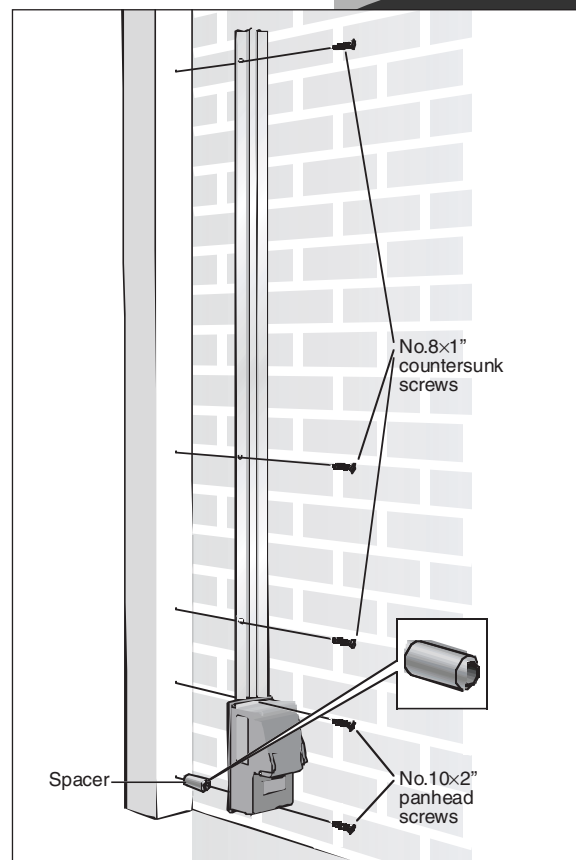

● Figure 11

AUTOGLIDE

smart entry system

4 Fitting the latches

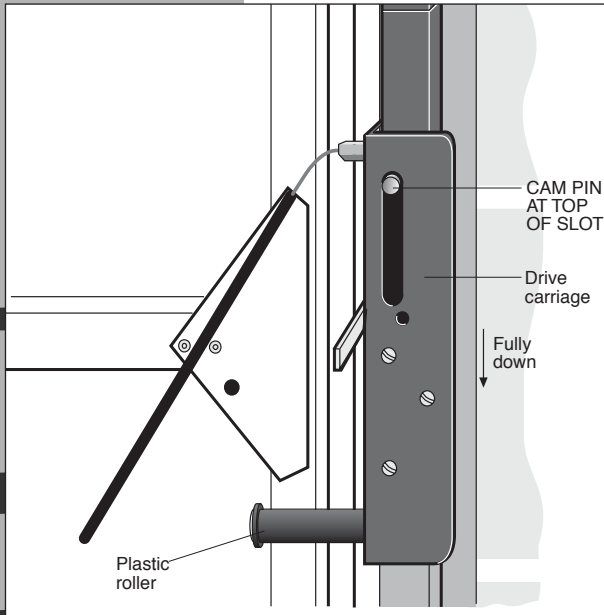

● Figure 12

NOTE: LATCH RELEASE CABLE

To avoid kinking the latch release during packaging/transit, the outer sheath of the cable is now supplied as a separate item in the kit box (item 14).

Prior to fitting the latch release cable (Section 4 in the fitting instructions) you simply need to slide the outer sheath over the cable that is already attached to the Autoglide unit then proceed as per the fitting instructions.

1 Ensure manual lever is still disengaged and fully close door. Ensure drive carriage is pushed as far down as it will go i.e. with cam pin at top of slot. (Figure 12).

2 Fit tilt bracket to door (Figure 13) 19mm ($\frac{3}{4}$ ") above plastic roller on tilt pin with drive carriage still fully down.

NOTE: Use the No 8 \times $\frac{3}{4}$ " countersunk screw in bottom hole and the No. 10 \times $\frac{3}{4}$ " pan head in the top hole (Figure 13) use 3.5mm diameter drill.

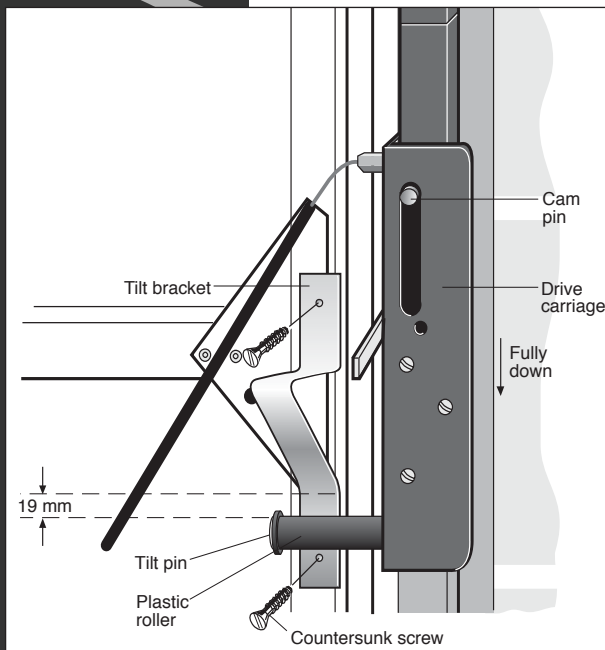

● Figure 13

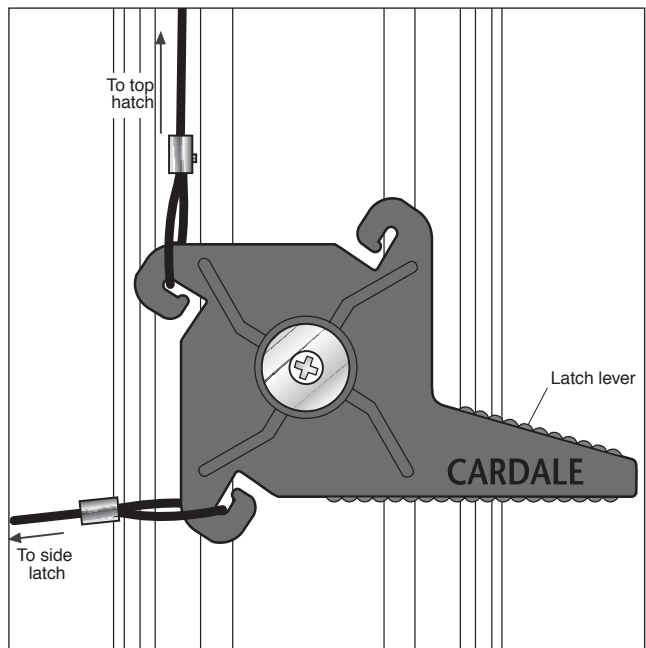

● Figure 14

AUTOGLIDE

smart entry system

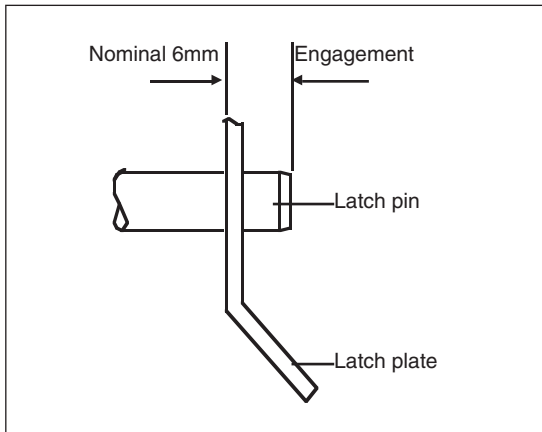

● Figure 15

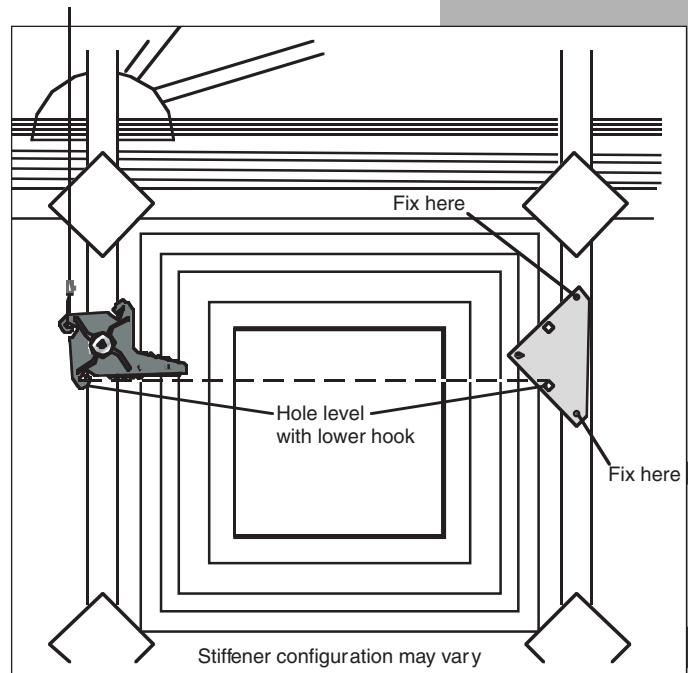

● Figure 16

- 3 Fit eurolock handle as per door fitting instructions and turn fully anti-clockwise (when viewed from outside). Place lock cam onto lock spindle with the tang pointing downwards, fit latch lever over lock cam in orientation shown (Figure 14) and secure using self tapping screw and washer.
- 4 Attach top and left-hand side latches as per door fitting instructions and attach cables to hooks on latch lever in configuration shown (Figure 14). Latch cable lengths must be adjusted to give approximately 6mm engagement of latch pins (Figure 15).
- 5 Attach triangular gusset plate to stiffener situated to the right of the latch lever (Figure 16). The gusset must be located with the lower 8mm diameter hole level with the lowest hook on the latch lever (Figure 16). Fix gusset to stiffener using 2 off No. 10 × 1/2" self tapping screws provided. (Drill holes 3.5mm diameter).
- 6 Attach cable adjuster through lower 8mm hole in corner gusset ensuring threaded end of adjuster is pointing towards latch lever and is **screwed completely into adjuster block (Figure 17)**.
NOTE: Highest hole on corner gusset should be kept available for exterior release system. The exterior release system is available from Cardale as an accessory.

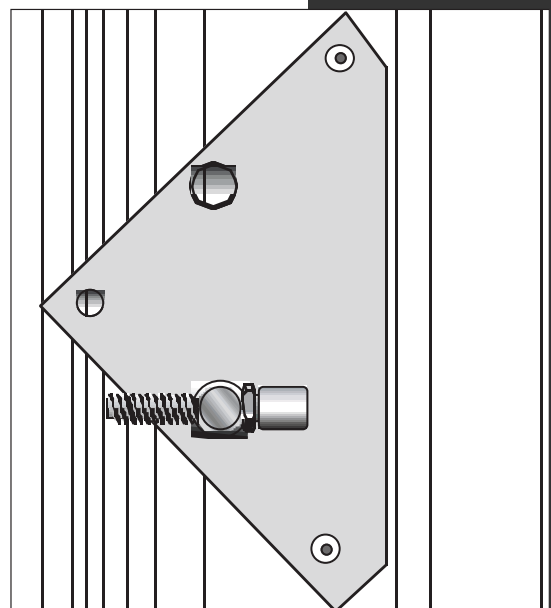

● Figure 17

AUTOGLIDE

smart entry system

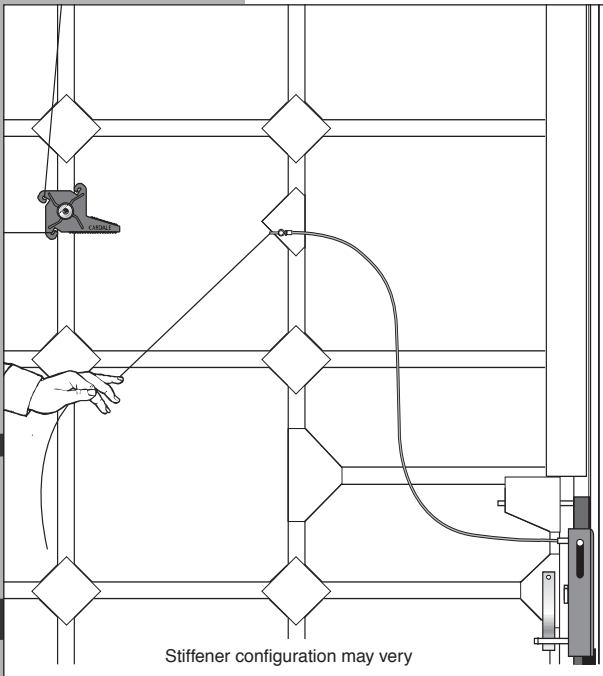

● Figure 18

7 Route latch release cable through cable adjuster and fix to door as shown (Figure 18) using cable ties supplied. Aim for smooth gentle curves on the cable run, avoid tight bends and kinks. **N.B.** Cut sheath to length if necessary to achieve best results.

8 Slide cable clamp over cable, pass cable through bottom hook of latch lever (Figure 19) and return cable through cable clamp. Tighten using M4 × 8mm Hexagon head screw supplied to give 6mm (1/4") engagement at both latches (Figure 15).

9 Force latch cam to the right across slot using a screw driver (Figure 20) to check operation of latches. Re-adjust latch settings if necessary.

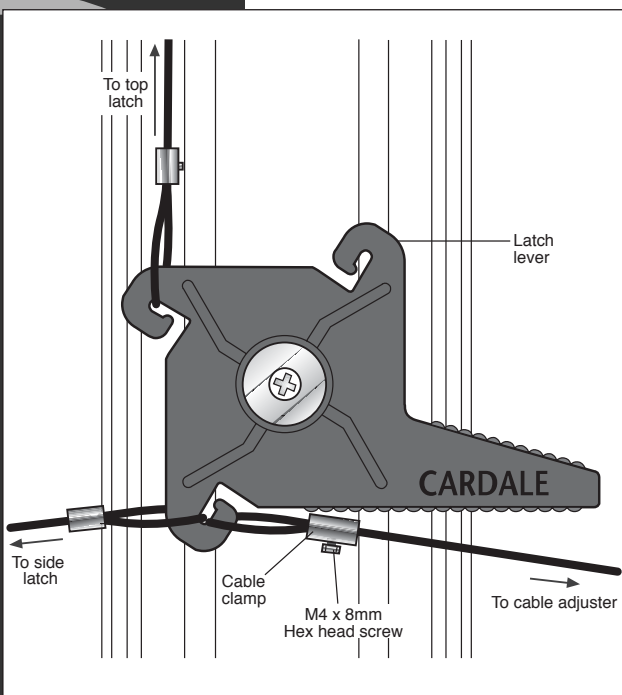

● Figure 19

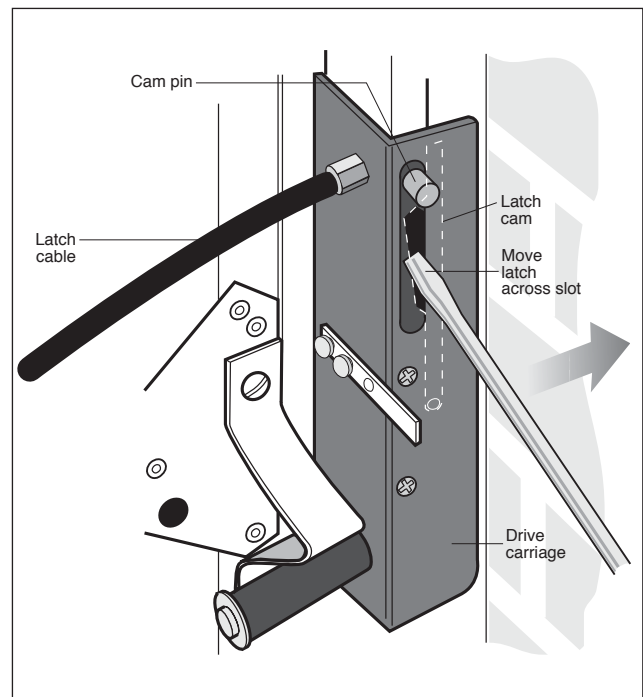

● Figure 20

5 Engaging the motor

- 1** Open door to identify position of 10mm diameter round hole in Dymetrol tape, this is marked with silver paint (**Figure 21**). Move the door so as to align the red manual release lever with the 10mm hole. Re-engage the drive pin in the 10mm diameter hole in the Dymetrol tape by operating the manual lever (see **Figure 7**).
N.B. To ensure drive pin is correctly engaged try to move door up or down manually, it should not be possible.
- 2** Move top (open) limit switch to a position 5mm from top of track (**Figure 22**).
- 3** Move bottom (close) limit switch to a position 15mm above motor (**Figure 23**).

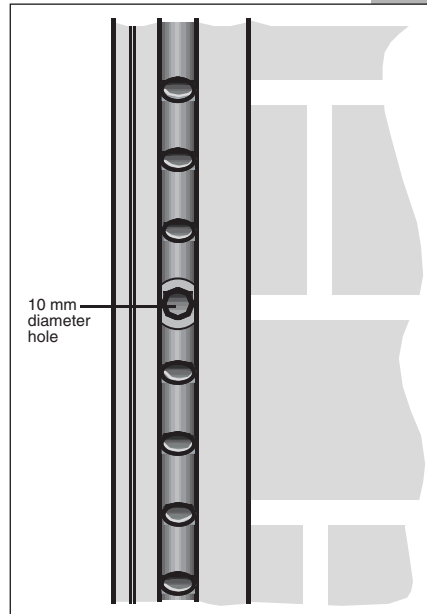

● Figure 21

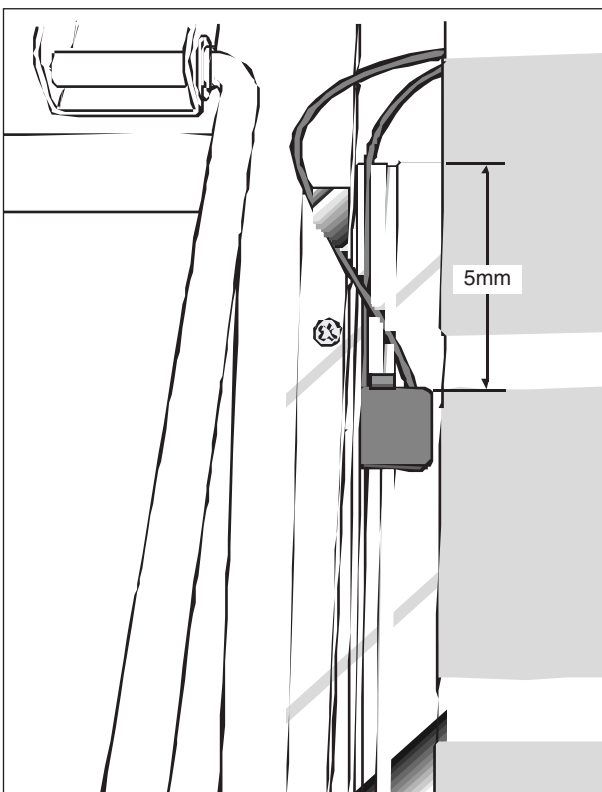

● Figure 22

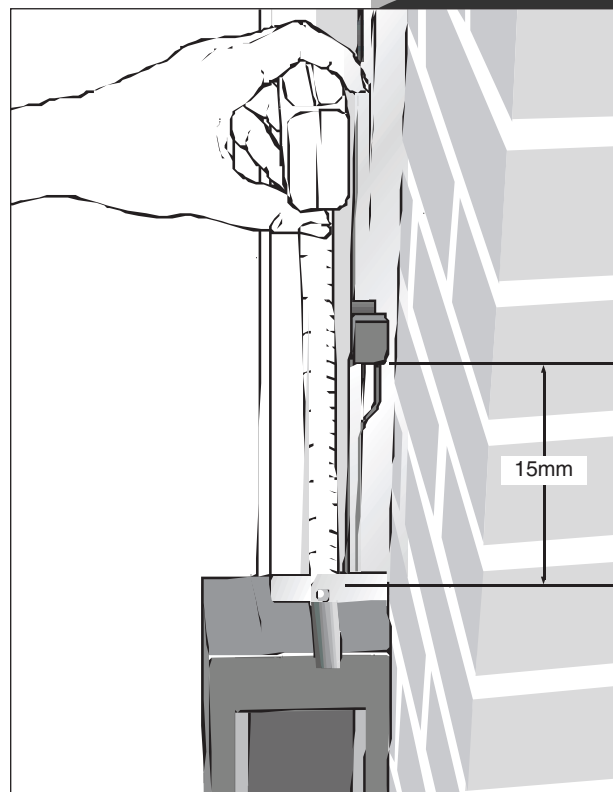

● Figure 23



6a Configuring the power and sensitivity set up

Ensure that the power switch on the unit is in the **OFF** position (see **Figure 25**).



NOTE: Before commencing power set up sequence ensure that:-

- a** Limit switches are adjusted to their nominal positions
- b** All latches operate correctly
- c** Drive pin is correctly engaged
- d** Door is clear of obstructions

Plug in the power supply cable (**Figure 25**) and turn on at the mains, but leave the switch on the unit turned **OFF** for the moment.

- 1** Press and hold down the  button. Turn on the unit power switch then release the button.
- 2** The **RED LED** above the button  should flash briefly to show door is between the limit switches. Briefly press the  button once to move the door to the fully open position.

NOTE: If the motor runs but the door does not move and the  LED flashes red, **TURN OFF POWER**. Ensure drive pin is correctly engaged in drive tape (see **section 5**) Then restart set up sequence.

- 3** With the door now fully open, briefly press the  button once to close the door for the **DOWN LEARN** sequence.
- 4** When the door is closed briefly press the  button again to open the door for the **UP LEARN** sequence.
- 5** The  LED should now show green or flashing green to confirm that set-up has been successfully completed.

NOTE: Where necessary, move the limit switches up or down (no more than 6mm at a time) to ensure the door fully opens and closes without excessive slamming. Go through stages 1-4 each time a limit switch is adjusted.

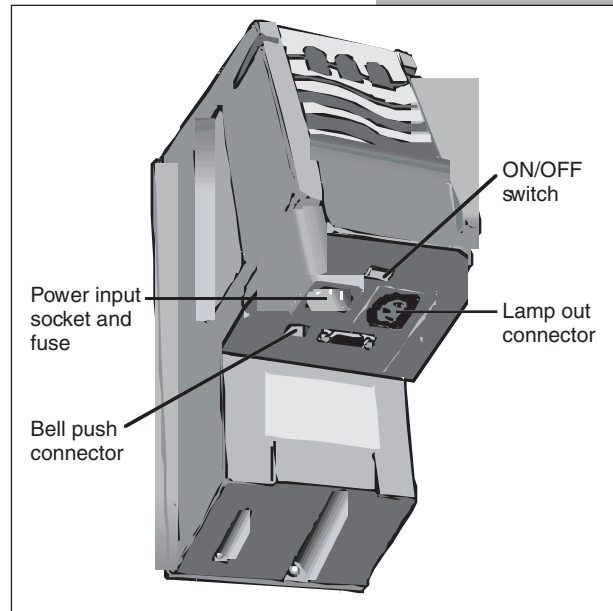

● **Figure 25**

CD PRO IMPORTANT NOTE: When setting TOP limit on CD PRO ensure the wheel spindle fully enters the SAFEHOLD on LH track.





AUTOGLIDE

smart entry system

6b Configuring the remote control handset

Ensure that the power switch on the unit is in the **OFF** position (see **Figure 25**)



Plug in the power supply cable (see **Figure 25**) and turn on at the mains, but leave the switch on the unit turned off for the moment.



- 1** Press and hold down the  button and turn on the unit power .
- 2** Release the  button.
- 3** Briefly press the  button again.
- 4** The  LED will light orange.
- 5** Press either button on the handset. The orange LED will go out.
- 6** Press either button on the handset again. The orange LED will flash for approx 10 seconds.



NOTE: To set up another handset repeat stages 5–6. When you have finished setting up the handset(s) continue with stage 7.

- 7** **Configuration of handset buttons** – with the  button released, press the handset button that you wish to use to operate the door.



The  LED should light orange to acknowledge receipt of the signal.

In addition, if the left handset button is pressed the  LED will flash red, if the right handset button is pressed the  LED will flash green.

If you want to change buttons, press both buttons on the handset simultaneously to reset (The  LED will flash orange briefly and the LED above  will flash red then flash green), and then repeat stage 7. 

- 8** To configure additional handsets also repeat stage 7.
- 9** Press the  button to store your settings.
- 10** The  LED should show green/flashing green, indicating that the handset(s) have been successfully configured.







NOTES:

- A** Up to a maximum of 8 handsets can be memorised into the control unit.
- B** If you wish to ERASE handset codes:-
- Follow previous instructions to step 2 inclusive.
 - Press and hold  button for 10 seconds and release (orange LED will flash).
 - Press  button to accept this instruction.
 - The  LED will now show GREEN/FLASHING GREEN indicating that you have returned to normal STANDBY MODE.
 - This will have erased ALL stored handset codes, if there are any that you wish to retain you must re-enter them by following previous steps 1-13.
- C** Courtesy lamp (if fitted).
- In standby mode it is possible to turn on the courtesy lamp (without operating the door) by simply pressing both buttons on the handset simultaneously.
 - The lamp will stay on for approximately 3 minutes before automatically turning itself off.

6c Configuring the child lock





Ensure that the power switch on the unit is in the off position (see **Figure 25**).

Plug in the power supply cable (see **Figure 25**) and turn on at the mains, but leave the switch on the unit turned off for the moment.

- 1** Press and hold down the  button. Turn on the unit power switch.
- 2** The  LED should briefly flash green.
- 3** Release the  button.
- 4** The  LED will now be red or green.
- 5** If RED, the lock is DISABLED i.e. door can be opened using the  button.
- 6** If GREEN, then lock is ENABLED i.e. door cannot be opened using the  button.

AUTOGLIDE

smart entry system

- 7** To change the status of the lock press the  button and the  LED will change to either red or green as the button is depressed.
- 8** To save the child lock settings press and release the  button.
- 9** If the lock is disabled the  LED will flash green (can open door).
- 10** If the lock is enabled the  LED will shine constant green (cannot open door).

NOTE: Whether the child lock is enabled or disabled, Autoglide can still be operated using the handset.



SAFETY NOTE: If there is a chance that children may play in the entry of the garage then ensure the child lock is **ENABLED** so that the door **CANNOT** be operated from the  button

7 Safety sensitivity check

Your Autoglide control system contains advanced electronics that monitor power over the full OPEN/CLOSE cycle and computes a SENSITIVITY FACTOR to ensure user safety.



To check the operation of this, signal the door to close and when it is halfway down obstruct the door at the bottom edge using both hands.

Using only light to medium force the door should stop and then reverse to the fully open position.

If excessively heavy force (or extremely light force) is required to stop the door then RE-CONFIGURE the POWER and SENSITIVITY SET UP as instructed in **Section 6A**.

8 Autoglide status modes

Stand by mode

When Autoglide is in stand-by mode the  LED is constant red which indicates "power on". The  LED will be either flashing green or constant green dependant upon child lock setting. If there is a problem detected, a flashing red LED will be seen. If this is the case turn the power supply switch on the unit OFF for 5 seconds then ON again to re-set the unit. See "Configuring your Autoglide operator" (Section 6). If the unit displays an alternate flashing red/green LED the unit has detected a fault, which may require a service call (see problem solving).

To operate the door press the nominated button on the key fob. If the child lock is disabled (flashing green LED) the door can also be operated by pressing the  button on the motor unit.

Obstruction

CLOSING When Autoglide detects a obstruction.i.e. something in the way of the door, or a stiff runner etc. the  LED will flash red for a short period.

If there has been an obstruction when the door is travelling **DOWN** (closing) the door will stop, the  LED will flash red and the door will reverse and return to the open position. As the door is opening the LED will be red until the door is fully open. It will then change to green/flashing green.

OPENING If there is an obstruction when the door is travelling UP (opening) the  will flash red for a period then change to green/flashing green. The door will remain in this position until the next command signal is received when it will then reverse and travel to the CLOSED position.

Handset

To check to see if the HAND SET is working press the selected handset button. An orange LED will light above the  button. Also a red LED will light on the handset.

If the handset battery is low the red LED will flash when the handset button is pressed. If so then replace the battery. This is done by removing two screws on the back of the key fob. Replace with the same type of battery (GP23AE).

AUTOGLIDE

smart entry system

9 Fitting the Remote bell push and Courtesy lamp

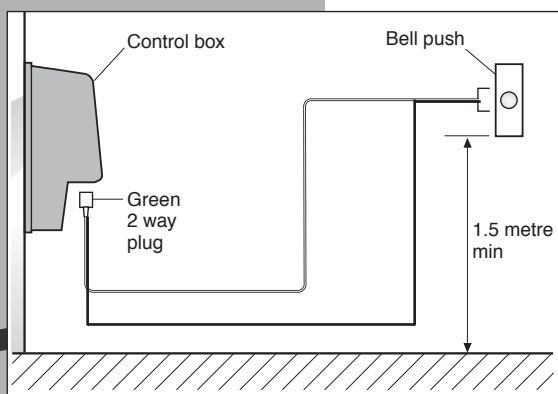

● Figure 26

9a Remote bell push

1 Your Autoglide is supplied with a Bell push so that you may have REMOTE push button control.

2 Fit the Bell push button in the required location using the yellow wall plugs and No 4 × 1" screws provided. Remember to mount at a minimum height of 1.5 metres (out of reach of small children) and for safety it must be within sight of the door to be operated, but not within the area of movement of the door.

3 Use twin core bell wire or telephone cable (not supplied) and connect the bell push to the green 2 way input plug on the control unit (see Figure 26).

4 Be sure to route the bell wire away from mains electric cables to reduce the possibility of electrical interference generating 'phantom' signals. Secure bell wire with suitable cable clips.

9b Courtesy lamp (if supplied)

1 Ensure mains power to the Autoglide unit is switched OFF.

2 Fix the courtesy lamp in the position you require, carefully following the fitting instructions supplied by the lamp manufacturer.

3 Measure the length of cable required to connect the courtesy lamp back to the Autoglide unit and obtain sufficient cable, which must be to the following specification:–

3 CORE 3183Y MAINS CABLE .75mm² 6 AMP

4 Connect one end of the cable to the lamp unit in accordance with the lamp manufacturers instructions.

IF IN DOUBT CONSULT A QUALIFIED ELECTRICIAN.

Fit 60W MAX GLS bulb to the lamp unit (not supplied)

5 Run the cable back to the Autoglide unit in a safe and professional manner in accordance with current IEE wiring regulations. Secure cable with suitable cable clips.

6 Ensure mains power to the Autoglide unit is switched OFF

7 Select the **lamp output connector (item 11)** from the parts supplied and using a small electrical screwdriver remove the connector cover by undoing the central screw.

8 Pass the cable through the shroud and under the cable clamp and then connect to the screw terminals as per Figure 27.

IF IN DOUBT CONSULT A QUALIFIED ELECTRICIAN

AUTOGLIDE

smart entry system

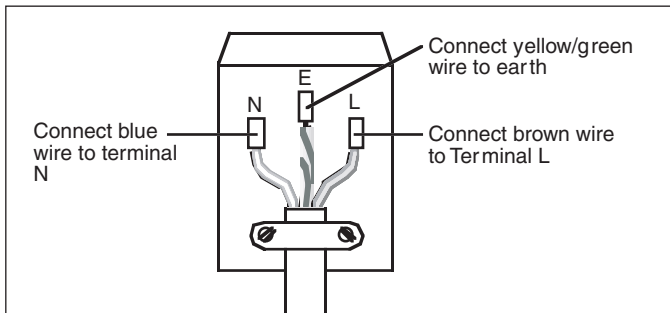

● **Figure 27**

9 When correctly connected ensure all terminal screws are tight, tighten the cable clamp and refit the connector cover.

10 Plug lamp output connector into the Autoglide unit. (see **Figure 28**)

11 Tidy up mains input, lamp output and bell wire cables using the cable clamp (item 6) and 2 off No 6 × 1/2" pan head self tap screws provided. (see **Figure 28**) **DO NOT OVERTIGHTEN.**

12 Switch mains power back on to the unit and test the lamps and the bell push by operating the door.

The lamp should come on as soon as the door is operated and go off automatically after approximately 3 minutes.

IMPORTANT NOTE: This unit can only be used with **INCANDESCENT** lamps. It must not be used with fluorescent or halogen lamps.

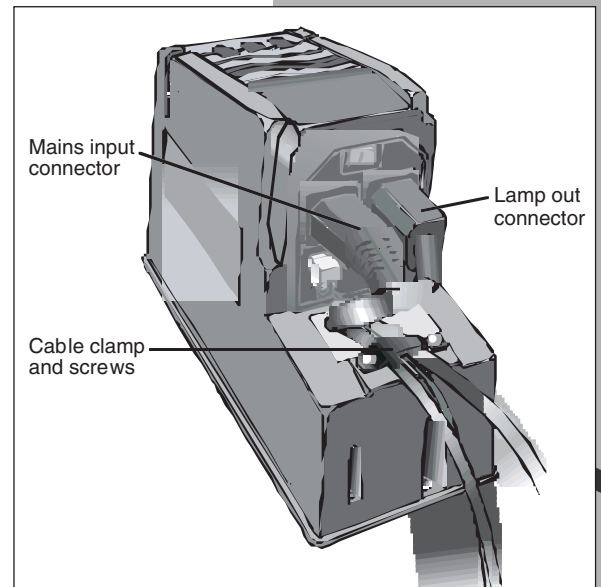

● **Figure 28**

10 Final checks

Upon completion of installation and when handing over to the end user the installer should carry out the following:-

- 1** Grease latch pins and latch cam, and ensure all screws and fixings are fully tight.
- 2** Check manual operation of the door to ensure correct balance.
- 3** Check operation of drive unit over full open/close cycle to ensure correct functioning.
- 4** Carry out Safety Sensitivity check.
- 5** Instruct end user in location and use of the Manual Release lever.
- 6** Explain function of Child Lock safety feature on the  button.

NOTE: If in doubt ensure that the child lock is **ENABLED** so that door **CANNOT** be operated from the  button (see **Section 6c**).

7 Ensure the User manual is left with the end user, as this contains important safety and warranty information.

11 Problem solving

1 UNIT FAILS TO OPERATE WHEN MAINS POWER SWITCHED ON.

a. If red LED above  is NOT LIT:–

- Remove power lead 13A plug from supply socket.
- Use test lamp to check power is available at the 13A socket.
- Check fuse in 13A plug (NB should be fitted with a 5A Fuse.)
- Remove power lead from the Autoglide unit.
- Check fuse in the Autoglide power input socket (see **Figure 25**)

N.B. Should be fitted with a 250v 2A slow blow × 20mm long fuse.

b. If Red L.E.D. above  is LIT:–

– Check if unit can be operated from either :–

- The remote handset.
- The  button on the control unit (provided child lock is disabled, shown by a flashing green LED).
- The remote bell push button.

If *any* of these operate the door then the unit is functioning properly.

The 'start' methods that failed to operate the door will need to be checked out separately, see in later sections.

– Should the unit fail to operate by any of the above "start" methods:–

- Turn the power switch on the unit to the OFF position.
- Wait for 5 seconds then turn back ON again. This will re-set the control system.
- Re-try "start" methods as above.

2 MOTOR OPERATES BRIEFLY BUT DOOR REMAINS FULLY CLOSED.

(the  LED flashes briefly RED)

- Door not de-latching correctly
- Check adjustment/operation of latches (**Section 4.8**)
- Check position/setting of tilt bracket (**Section 4.2**)

3 MOTOR OPERATES BUT DOOR DOES NOT MOVE (MOTOR RUNS ON)

(the  LED flashes intermittent RED)

- Motor drive not engaged
- Check drive pin correctly engaged (**Section 5**)

4 MOTOR OPERATES BUT DOOR FAILS TO FULLY OPEN OR CLOSE.

(the  LED flashes briefly RED)

- Turn OFF mains power to unit and read safety notes at the front of this manual.

- ii Operate manual release lever to disengage drive (**Section 3.5**)
- iii Test door operation and correct any binding or out of balance.
- iv Re-engage drive (**Section 5**) and turn power back on.
 - Reconfigure power and sensitivity settings (see **Section 6a**)

5 DOOR CLOSSES BUT LATCHES DO NOT ENGAGE

- Check that drive carriage has been pulled down to its lowest position (see Figure 12 in **Section 4**).
- Check latch cable settings (**Section 4.8**)
- Check tilt bracket setting (**Section 4.2**)
- Grease latch release cam and pin on drive carriage.
- Grease latch plates and latch pins on door.
- Check bottom limit switch has been set low enough to ensure ‘slam action’ of latches.

6 DOOR SHUTS TOO VIOLENTLY OR SHUTS AND THEN OPENS AGAIN IMMEDIATELY.

- Adjust the bottom limit switch to a slightly higher position.

7 UNIT FAILS TO OPERATE AND LED FLASHES ALTERNATE RED/GREEN.

- Indicates a limit switch fault:–
 - i Switch off power to unit and read **safety notes** at front of this manual.
 - ii Operate manual release lever to disengage drive (**Section 3.5**) and manually move door to half open position.
 - iii Check operation of both limit switches by depressing the small plunger pin several times to ensure that it springs back out again, and that there is an audible ‘click’ from the switch.
 - iv RE-engage drive (**Section 5**) and turn power back on.
 - v Test operation again.

If L.E.D. still flashes alternate RED/GREEN then a limit switch is damaged/faulty and will require a service engineer visit.

8 UNIT FAILS TO OPERATE FROM REMOTE BELL PUSH.

- Check connections to bell push are correct and secure.
- Check operation of bell push button “makes/breaks” the contacts.
- Check wiring for damage/breaks and is routed away from any mains electrical cables.
- Check connections to 2 way plug in Autoglide unit are correct and secure.
- Check 2 way plug is fully engaged into socket in Autoglide unit.

AUTOGLIDE

smart entry system



9 UNIT FAILS TO OPERATE FROM REMOTE CONTROL HANDSET

- Check that signal is being sent from the handset. (see **Section 8** page 19).
- Check that Autoglide unit is receiving the signal. The  orange LED should light up when the handset is pressed to indicate that signal is being received.

if this fails to happen:-

- i Check that handset has been configured into the control system (see **Section 6b**).
- ii Check that correct handset button has been pressed (try other button to make sure)
- iii Check handset signal (see above).

10 UNIT FAILS TO OPERATE FROM BUTTON.

- Check that the unit has been configured to operate  button. (flashing  green LED)

To change configuration refer to **Section 6c** paying particular attention to the **SAFETY NOTE**.

The following accessories are available for use with your Autoglide MK III operator

| | |
|-----------|---|
| AZAA 3152 | Additional handset (433 MK III-A) |
| AZAA 3120 | Exterior release kit (Cardale CD45) |
| AZAA 3141 | Lamp kit |
| AZAA 3160 | Electric key switch |
| AZAA 3101 | Retro fit kit for Henderson Premier (cable latch) |
| AZAA 3102 | Retro fit kit for Garador Mk III 'C' |
| AZAA 3103 | Retro fit kit for Henderson Premier (solid bar) |
| AZAA 3104 | Retro fit kit for Henderson Pre-premier doors (after 1987) |
| AZAA 3121 | Exterior Release kit for Henderson Premier (cable latch) |
| AZAA 3122 | Exterior Release kit for Garador Mk III 'C' |
| AZAA 3123 | Exterior Release kit for Henderson Premier (solid bar) |
| AZAA 3124 | Exterior Release kit for Henderson Pre-premier (after 1987) |
| AZSP 7036 | Replacement handset battery (GP23AE) |

In the event of difficulty please consult your local Cardale dealer (see Yellow Pages) or contact Cardale service department 01280 705077.