



# Glidermatic™

Commercial Door Operator



*'Opening doors around the world!'*®



# Glidermatic™

## Commercial Door Operator

# Important Safety Instructions

- DO NOT operate unless the door is completely visible and clear of obstructions including children, persons, vehicles or other objects. SEVERE PERSONAL INJURY, property damage or even DEATH may result if this warning is not followed
- DO NOT operate the door if children or persons are near the opening. Children must always be supervised when near the door at all times the operator is in use
- DO NOT allow children to operate the door. SEVERE PERSONAL INJURY, property damage or even DEATH may result if this warning is not followed.
- The SAFETY REVERSING function should be tested on a monthly basis to ensure it is set correctly and the door will reverse on its downward motion when an obstruction is encountered. If this function does not operate DISCONTINUE USE and contact a qualified service technician.
- If additional SAFETY is required, it is STRONGLY recommended that a Photo Electric Cell or Sensing Edge device be installed. It is mandatory that such devices be used in conjunction with radio control units or when momentary contact on close function is enabled.
- When the Automatic Close function or Radio Transmitters are being used, a Sensing Edge or Photo Electric Cell must be correctly fitted and tested on a regular basis. If SAFETY features do not operate correctly, DISCONTINUE USE and contact a qualified service technician.
- When possible activate the manual release only when the door is closed. Weak or broken springs may allow the door to fall rapidly, causing SEVERE INJURY or even DEATH. In all cases stand clear of the door. In the event that the door appears to fall, a qualified service technician will be required to adjust the spring tension.
- Install the control unit on the same side of the door as the drive unit with an uninterrupted view of the door and opening. The control unit should be installed in a suitable location to ensure it is protected from the elements. Under NO CIRCUMSTANCES should the unit be exposed to water.
- When installing the operator on an existing door, ensure it is good operating order. Ensure the springs are not weak or broken and the door is free of sticking or binding. Contact a qualified service technician for attention to any of these issues.
- If any wiring is damaged, it MUST BE replaced by a qualified service technician in accordance with the manufacturer's detail.
- Ensure the door is completely open before proceeding through the doorway.

# Drive Unit

## Exploded Parts Diagram

1. Drive unit 1/2 HP DC motor(s)
2. Gear Heads
3. Planetary gear housing
4. Drum wheel
5. Open and close limit switches
6. Cam gears
7. Emergency chain hoist
8. Plunger
9. Cut-out switch

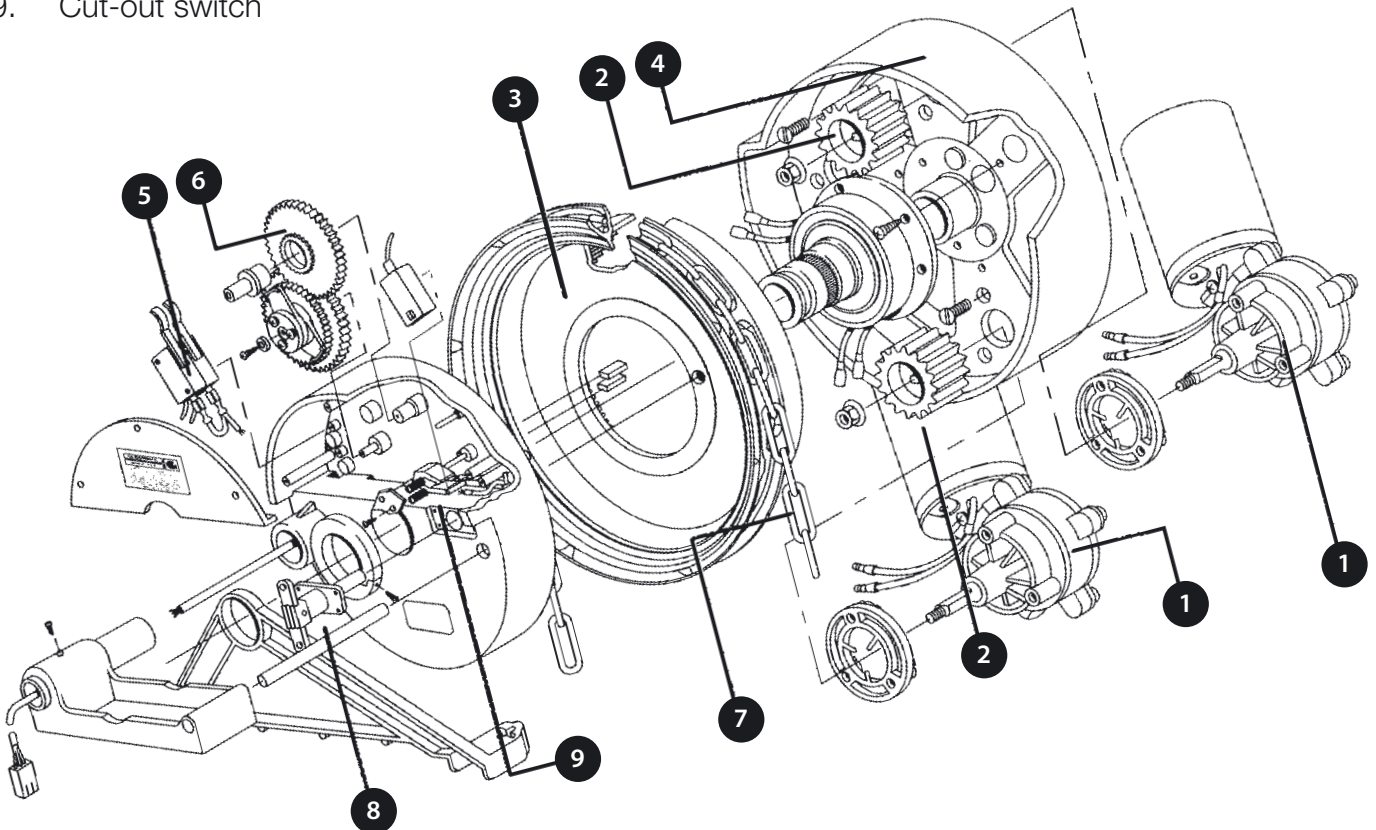

This manual refers to settings and connections to be performed on the DRIVE UNIT and CONTROL UNIT, not the installation of the door.



# Glidermatic™

## Commercial Door Operator

## Control Unit

The CONTROL UNIT is best mounted on the same side as the drive unit with an uninterrupted view of the door.

It is essential that the CONTROL UNIT be securely attached to the wall or structure involved through the mounting holes provided.

Connect the CONTROL UNIT to a 240-volt single phase AC 5.0 AMP power source, being sure to follow local wiring codes.

Ensure the unit is properly grounded using the grounding post (green lead) in the splice connection area.

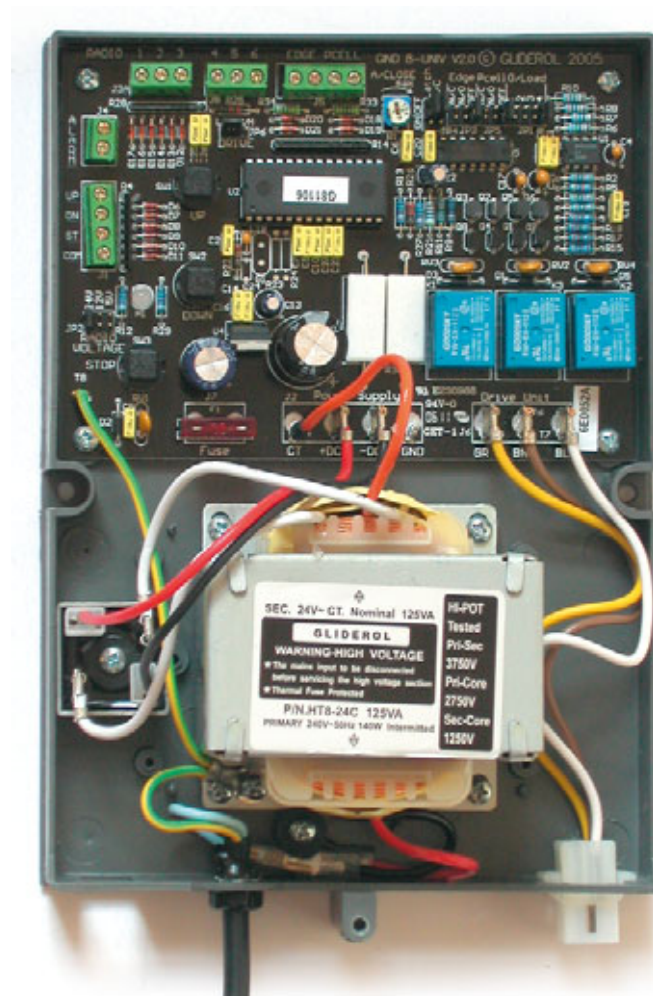

# Handing of the Operator

The Glidermatic Operator may be fitted to either the left hand or right hand side of the door, viewed from the inside looking outward. However, all units as standard factory issue are configured to Right Hand operation. If required the handing of the operator may be changed by setting jumper **JP6**.

**CAUTION:** Always disconnect power to unit **BEFORE** making these setting changes.

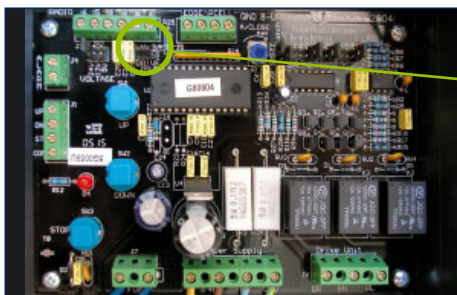

1. Set jumper **JP6** according to whether the operator is installed for **Right Hand** or **Left Hand** operation

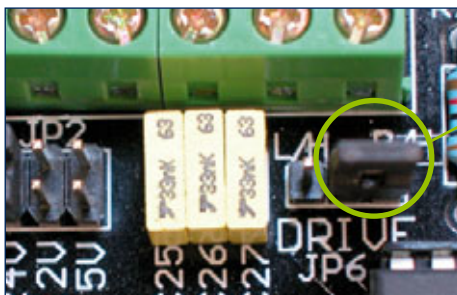

2. For **Right Hand** operation (RH) ensure the jumper is set according to diagram

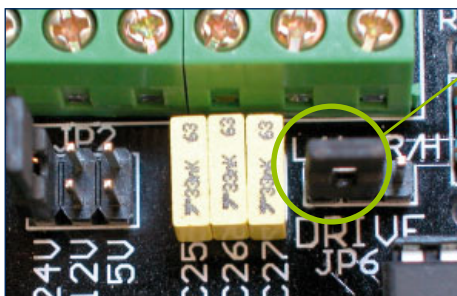
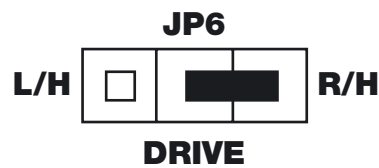

3. For **Left Hand** operation (LH) ensure the jumper is set according to diagram

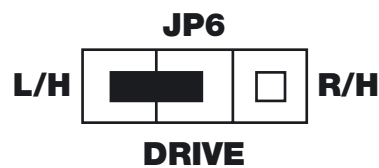

## Manual Operation

In the event of power failure or situations where manual operation of the door is required. Manual operation is activated by use of the **Manual Release Lever**. Activating the **Manual Release Lever** will automatically disconnect electrical power to the motor. The motor will not operate unless the lever is fully engaged in the electric operation position.



**Manual Release Lever**

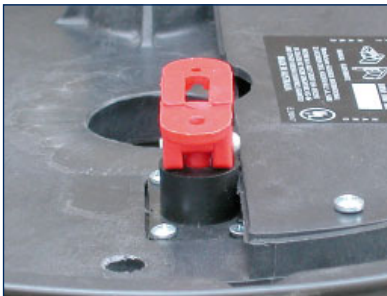

**Electric Operation**



**Manual Operation**



When normal electric operation is required, return the lever to the **Electric Operation** position. Engage the spring loaded release pin by carefully moving the door in either direction until pin engagement is noted and the unit is locked in position

### **WARNING:**

When possible activate the manual release only when the door is closed. Weak or broken springs may allow the door to fall rapidly, causing severe injury or even death. In all cases stand clear of the door. In the event that the door appears to fall a qualified service technician will be required to adjust the spring tension

# Door Travel Adjustment

The door travel limit is determined by rotation of **cams** in the drive unit. The cams are driven by a gear mechanism and activate a limit switch at the desired position.

- The **inner cam** determines the **closed** position.
- The **outer cam** determines the **open** position.

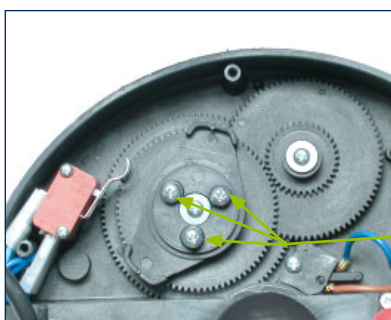

## To adjust

- Set door to manual operation using the manual release lever (Refer to **Manual Operation**)
- Remove the cam gear cover on the drive unit to gain access to the internal **cams**
- Loosen **cam gear screws** (x3)

## Closing - inner cam

- To set the **closing position**, manually lower the door to the required closed position observing the direction of rotation of the **inner most cam**
- Rotate the **inner cam** in the direction observed until it activates the inner **limit switch**

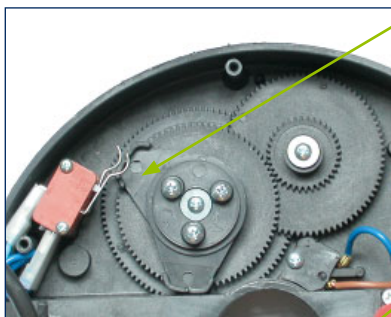

## Opening - outer cam

- To set the **opening height**, manually raise the door to the desired open position (ensure the bottom bar is short of contacting the head stop), observing the direction of rotation of the **outer cam**
- Rotate the **outer cam** in the direction observed until it activates the outer **limit switch**

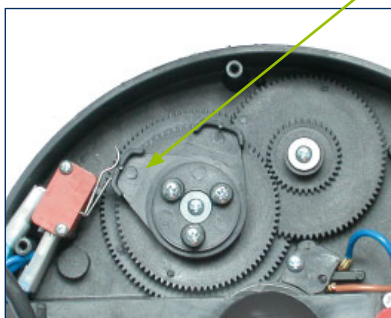

## To complete

- Tighten the **cam gear screws** (x3)
- Return **manual release** lever to **normal** position
- Carefully move the door in either direction until pin engagement is noted and the unit is locked into position (Refer to **Manual Operation** on page 5)
- Reinstall the cam cover after operating door electrically and verifying limits of door travel.

Care should be taken to ensure the lever arms on the limit switch are not obstructed by the rotation of the gearing.

**CAUTION:** The motorised travel of the door is directly controlled by the Cam adjustment settings. Please ensure the required door travel is correctly set.

# Push Button Operation

All control units as standard issue are configured to operate with push button operation featuring momentary contact to open and constant contact to close, as such:

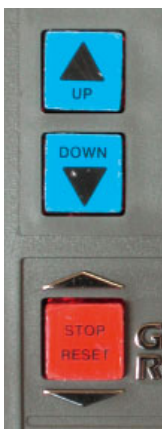

## Momentary Contact to Open

**UP** A single press will operate the door in the upward direction.

## Constant Contact to Close

**DOWN** Continuous pressure needs to be applied to the down button to drive the door downward (Hold to run). Releasing this button will stop the door.

**STOP/RESET** Pressing this button will STOP the door

**CAUTION:** Always disconnect power to unit BEFORE making any setting changes.

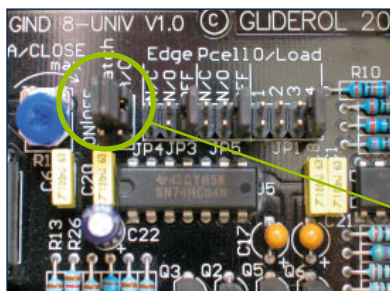

## Momentary Contact on Close

It is possible to convert the push button operation to **Momentary Contact** to Close from **Constant Contact** to Close.

This will enable a single press of the button to close the door.

To enable this, move jumper on **JP4** Latch terminal from OFF to **ON**

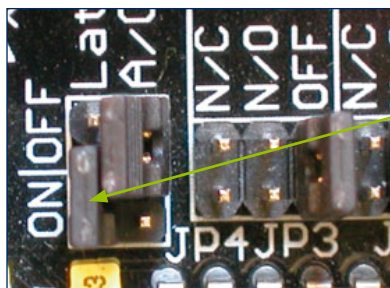

When enabling momentary contact closing operation it is essential that a supplementary safety device such as a **Sensing Edge** or **Photo Electric Cell** be fitted to prevent injury or entrapment. Once enabled for momentary contact on close - the unit will not operate unless a supplementary safety device is fitted and the jumpers at **JP3** and **JP5** set accordingly. Refer to pages 9 and 10.

# Safety Reversing

An inherent safety feature of the Glidermatic operator is the overload function. This ensures that a closing door will stop and reverse motion if an obstruction is encountered

**CAUTION:** Always disconnect power to unit BEFORE making any setting changes.

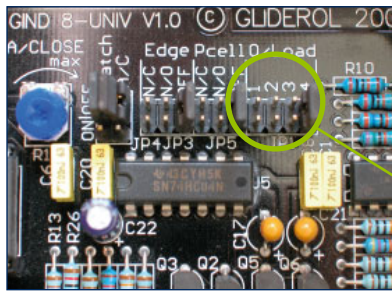

## Torque Setting

The Glidermatic operator is designed to stop and **reverse downward** operation if it encounters an obstruction. This is set by adjusting **JP1** to the lowest current that will allow the door to close during normal operation.

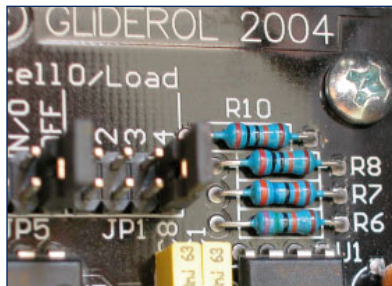

Start by testing with the jumper **JP1** set at **4**. If the door will not close, proceed testing with **JP1** set at **3**. Continue setting **JP1** until the door will completely close.

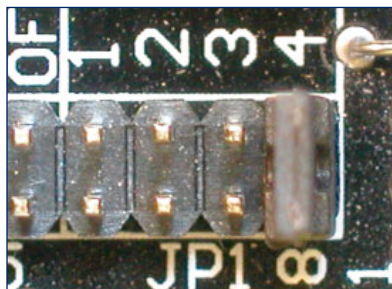

- The current settings are:**
1. 7.5 amps (largest door)
  2. 6.5 amps
  3. 5.5 amps
  4. 4.5 amps (smallest door)

The overload function should be tested on a regular monthly basis to ensure the door will reverse on its downward motion when an obstruction is encountered. If this function does not operate discontinue use and contact a qualified service technician.



# Photo Electric Cell Wiring

Consult the installation instructions supplied by manufacturer of the **Photo Electric Cell** and determine whether the contacts are normally open (N/O) or normally closed (N/C).

**CAUTION:** Always disconnect power to unit BEFORE making any setting changes.

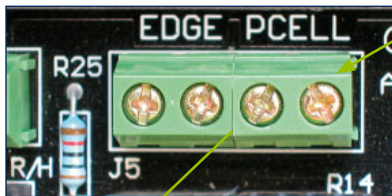

Connect the two wires from the **Photo Electric Cell** receiver output terminals to the terminals marked **PCELL** on wiring terminal **J5**.

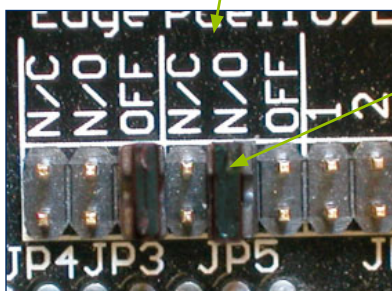
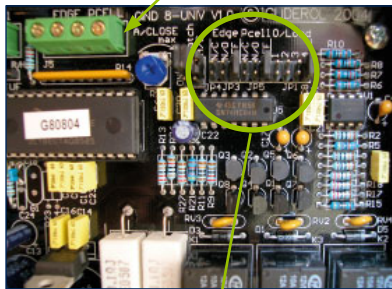

If the **Photo Electric Cell** output uses **normally open** contacts, move jumper on **JP5** from **OFF** to **N/O**.

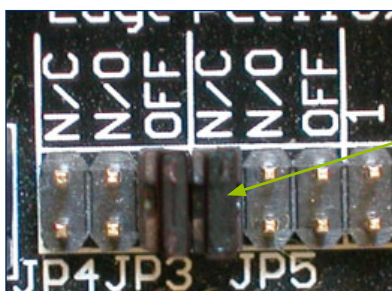

If the **Photo Electric Cell** output terminals feature **normally closed** contacts, move jumper on **JP5** from **OFF** to **N/C**.

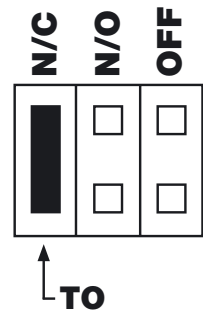
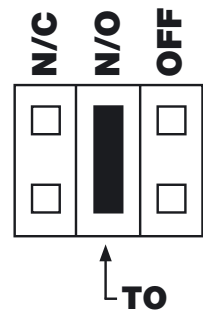
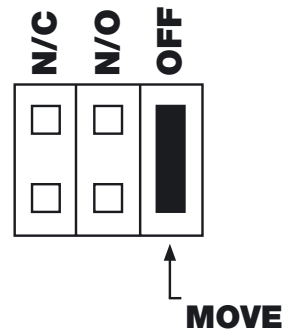
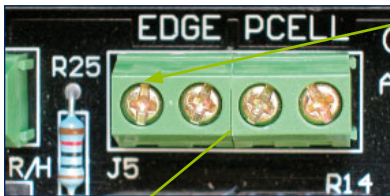

**Photo Electric Cells** are recommended as a supplementary safety system. If required, 12 or 24 VDC power may be sourced from terminals **5 & 6 of J3**. Ensure jumper **JP2** is configured to match required voltage of photo electric cell. Refer to page 11.

# Sensing Edge Wiring

Consult the installation instructions supplied by manufacturer of the **Sensing Edge** device and determine whether the contacts are normally open (N/O) or normally closed (N/C) .

**CAUTION:** Always disconnect power to unit BEFORE making any setting changes.



Connect the two wires from the **Sensing Edge** terminals marked **EDGE** on terminal block **J5**.

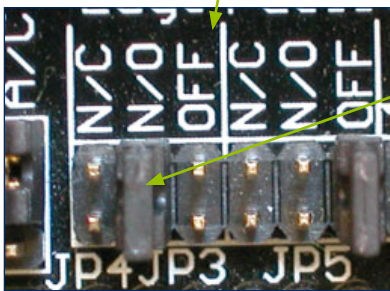
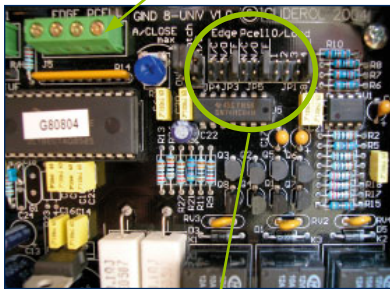

If the **Sensing Edge** contacts are **normally open**, move jumper on **JP3** from **OFF** to **N/O**.

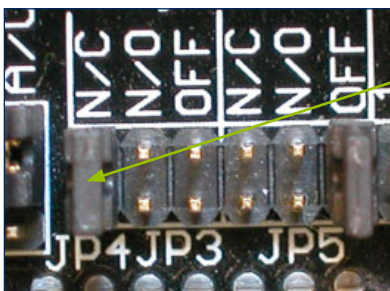

If the **Sensing Edge** features **normally closed** contacts, move jumper on **JP3** from **OFF** to **N/C**.

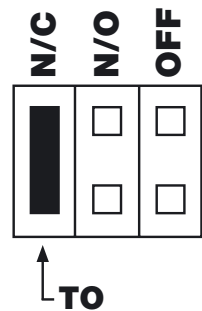
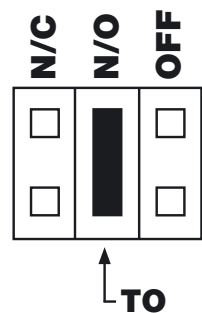
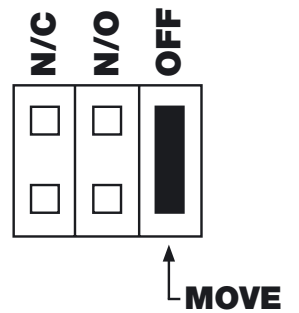

**Sensing Edge** devices are recommended as a supplementary safety system. If required, 12 or 24 VDC power may be sourced from terminals **5 & 6 of J3**. Ensure jumper **JP2** is configured to match required voltage of sensing edge. Refer to page 11.

# Radio Control Wiring

In order to operate the door with a wireless remote, an independent **Radio Control Unit** may be installed and connected to the Glidermatic control unit.

**CAUTION:** Always disconnect power to unit BEFORE making any setting changes.

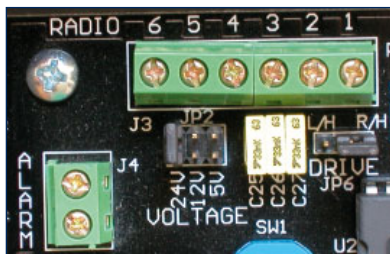

Power to the receiver is supplied from terminals **5** & **6** of **J3**

**5** is **+v**, **6** is **ground**

Ensure Jumper **JP2** is configured to match required voltage of **radio control receiver**. (5, 12 or 24VDC)

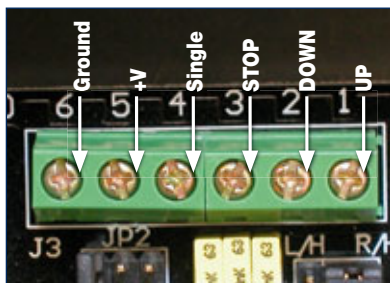

### Single (Up/Down) Output Type Receiver

Connect output of receiver to terminal **4** of **J3**

### Open/Close/Stop Type Receiver

Connect terminals Up, Down and Stop of Radio Control Receiver to **1, 2 & 3** respectively

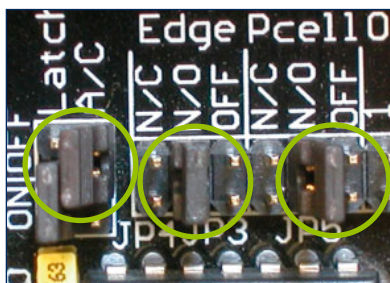

Ensure the jumper **JP4** Latch terminal is set to **ON**

**Edge** jumper **JP3** is set to **N/O** or **N/C**

**Pcell** jumper **JP3** is set to **N/O** or **N/C**

In accordance with the instructions supplied by the manufacturer of the supplementary safety system

It is essential that a supplementary safety device such as a **Sensing Edge or Photo Electric Cell** be fitted when radio control unit is installed to prevent injury or entrapment

Once any radio receiver unit is connected the unit will not operate unless a supplementary safety device is fitted and the jumpers at **JP3** and **JP5** set accordingly. Refer to pages 9 and 10.

# Automatic Close Function

The Glidermatic operator can be configured to automatically close the door after a prescribed period of time up to 12 minutes

**CAUTION:** Always disconnect power to unit BEFORE making any setting changes.

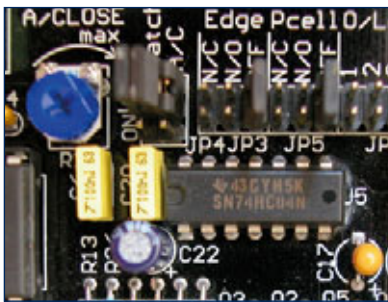

## Enable Automatic Close (JP4)

To enable the Automatic Close Function, move Jumper on **JP4 A/C** terminal from OFF to **ON**

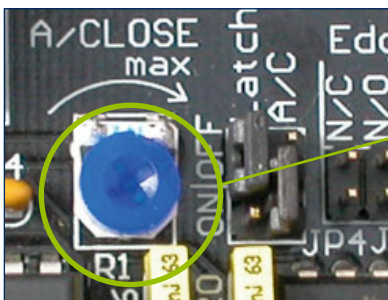
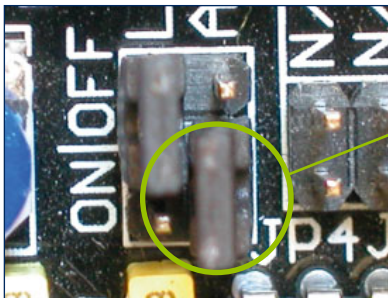

## Adjust timer

Timer can be adjusted using the potentiometer **A/CLOSE** to achieve a maximum time delay of 12 minutes

It is essential that a supplementary safety device such as a Sensing Edge or Photo Electric Cell be fitted when the automatic close function is in use to prevent injury or entrapment

# Alarm Function

The Glidermatic operator can be connected to a security system to activate an alarm when an attempt is made to open a closed door.

**CAUTION:** Always disconnect power to unit BEFORE making any setting changes.

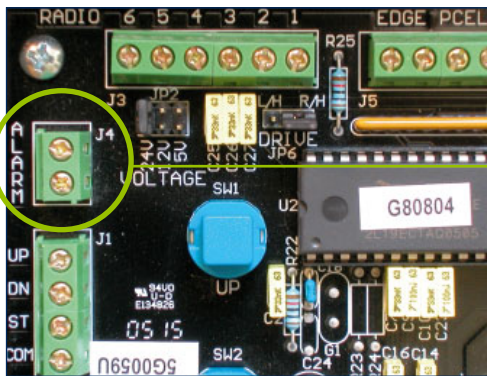

## Alarm Wiring

A 5 volt DC signal is sent to terminal **J4** in the event an attempt is made to force the door open. This is designed to interface to an alarm panel.

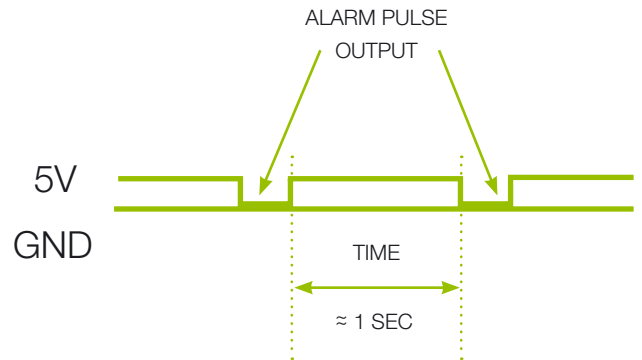
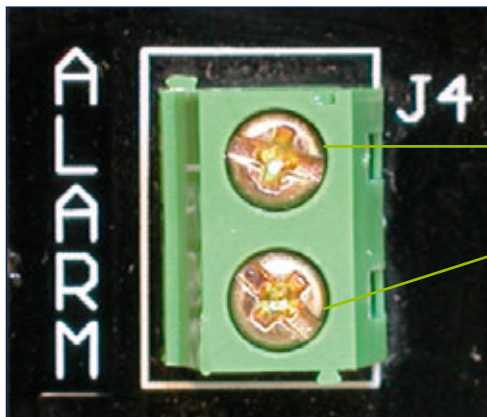

Consult the installation instructions supplied by the manufacturer of the alarm being used for connection and relay details